

P/N: AMT-DP100400

Technical Specification

	Frequency Range(GHz)	10.0-40.0GHz
	Gain (dBi)	13 Typ.
	Polarization	Dual Polarized
	Port to Port Isolation(dB)	20 Min.
	Cross Polarization Isolation(dB)	20 Min.
	Impedance(Ohms)	50
	Connector	2.92mm-female/ 2.4mm-female(optional)
	VSWR	2.5 Max.
	Material	Gold plated brass
	Weight(g)	100 approx.

Outline (mm)

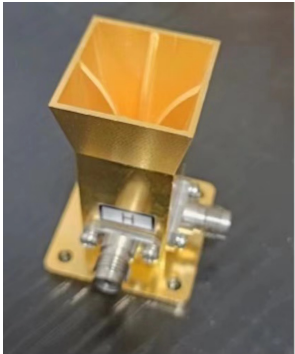
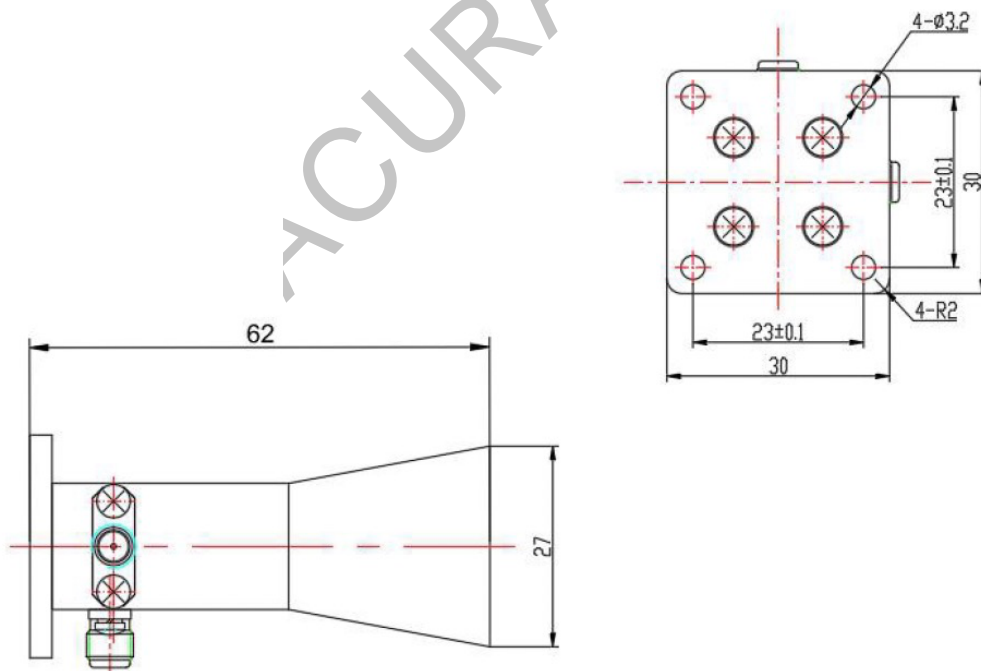



Test Result

Gain

Frequency	Gain(dBi) Port 1	Gain(dBi) Port 2
10	9.7	9.7
12	10.9	10.9
14	12.0	12.0
16	12.1	12.0
18	12.0	12.1
19	12.3	12.2
20	12.7	12.5
21	12.9	12.7
22	13.1	12.8
23	13.5	13.6
24	13.7	13.5
25	13.9	14.1
26	14.1	14.3
27	14.4	14.7
28	14.7	14.8
29	15.1	14.6
30	15.2	15.3
31	15.4	15.8
32	15.2	15.5
33	15.3	15.6
34	15.4	15.7
35	15.7	16.2
36	16.7	16.6
37	17.2	16.8
38	16.3	16.5
39	16.7	16.9
40	16.3	16.6



VSWR

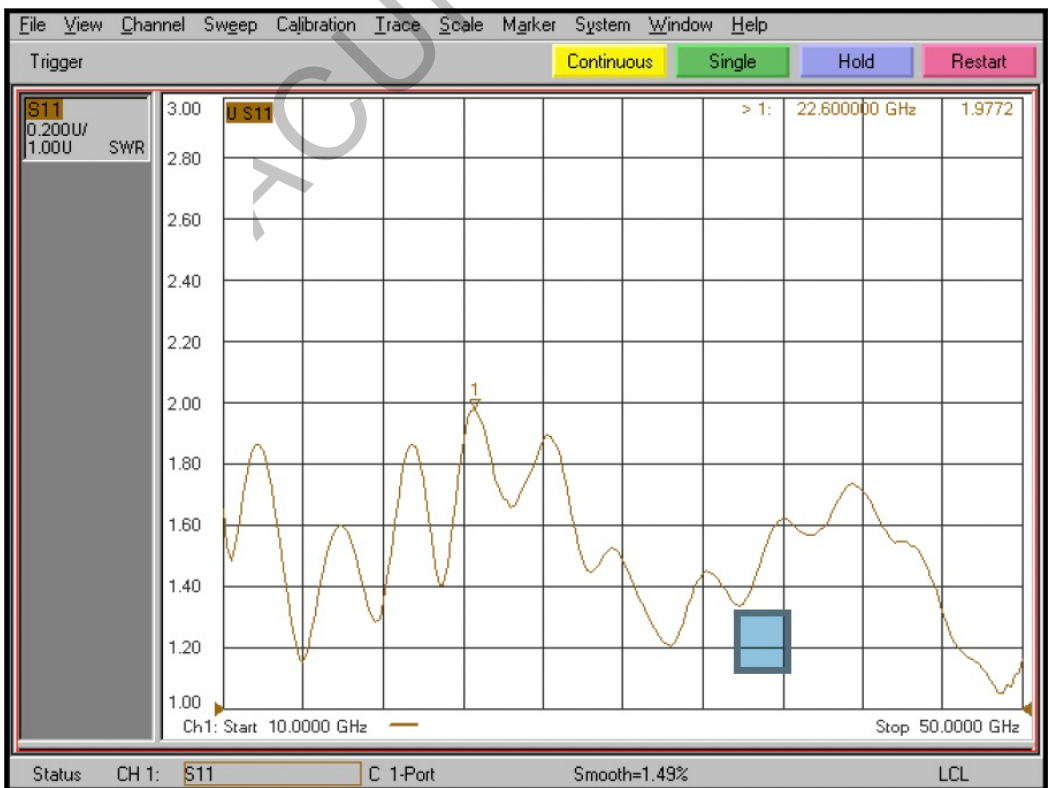
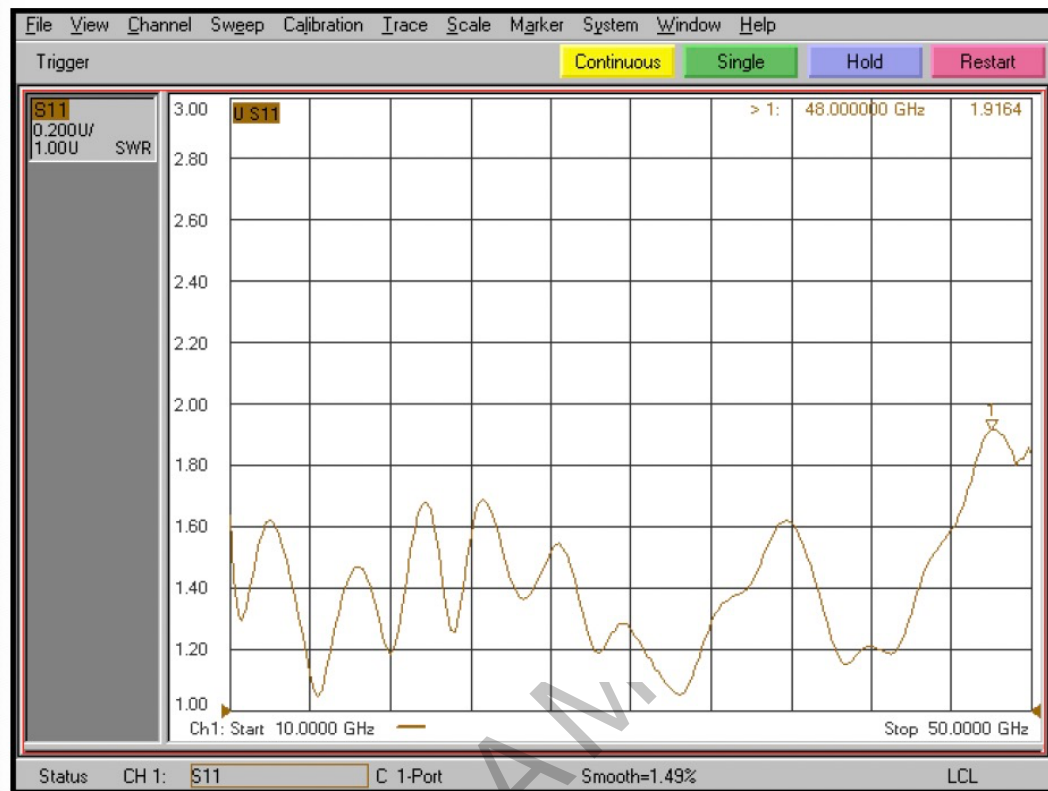

Port to Port Isolation(dB)

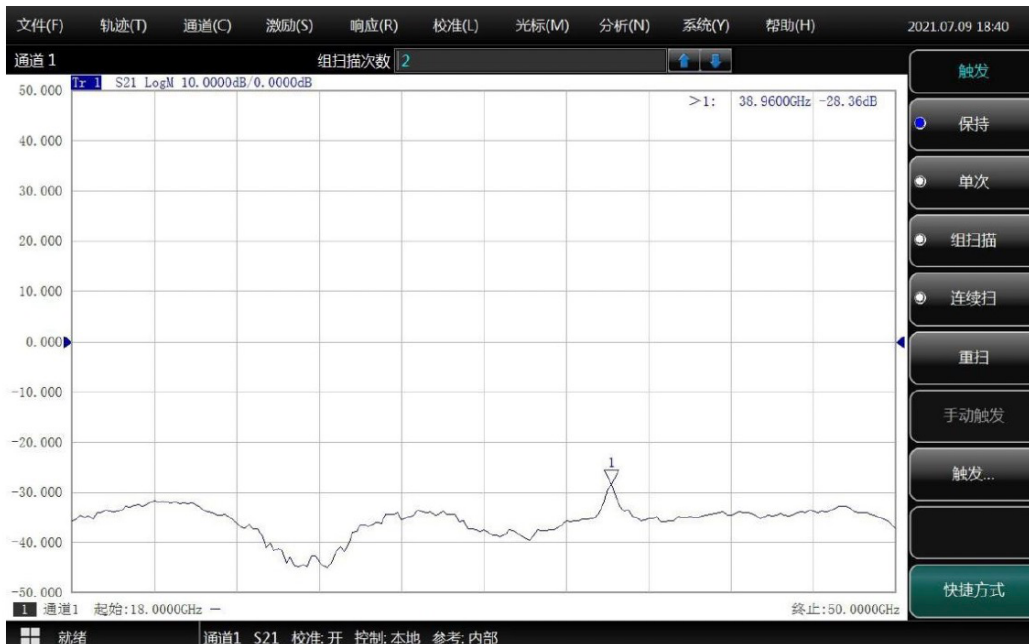

Cross Polarization Isolation(dB)



Patterns

Frequency :14GHz

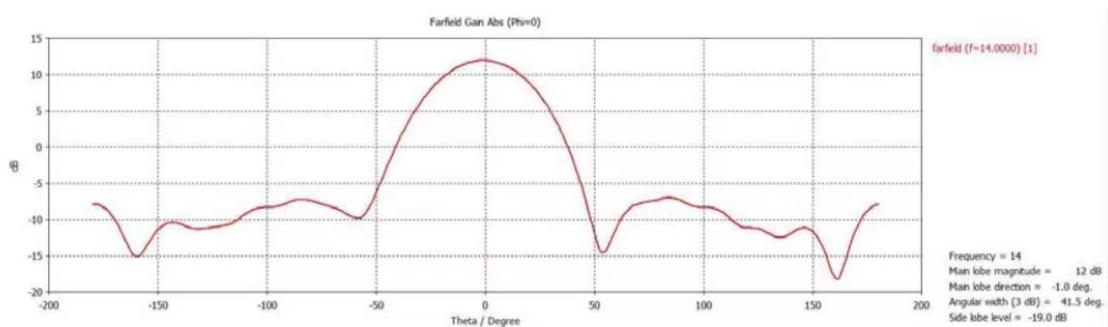

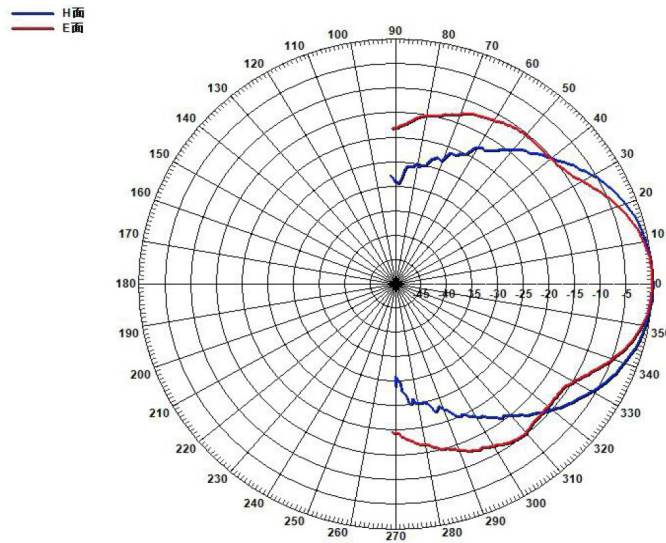

端口: 1
 频率: 18GHz
 增益: 12.03 dB
 H面波束宽度:
 -3dB: 42.78°
 E面波束宽度:
 -3dB: 32.61°

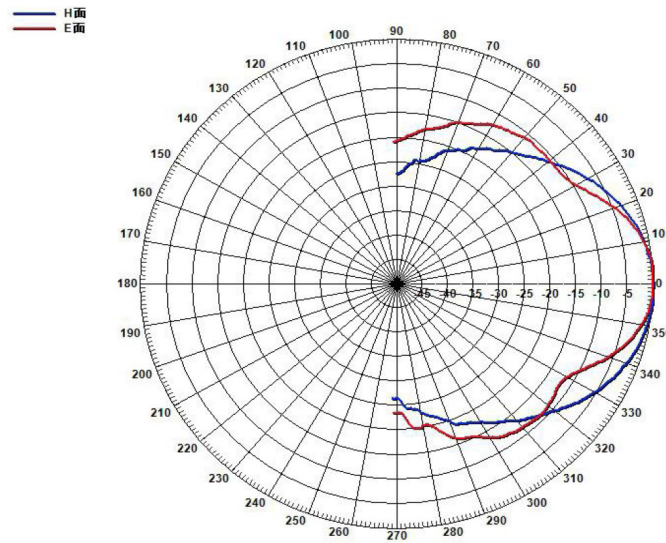

端口: 1
 频率: 20GHz
 增益: 12.7 dB
 H面波束宽度:
 -3dB: 40.23°
 E面波束宽度:
 -3dB: 29.77°

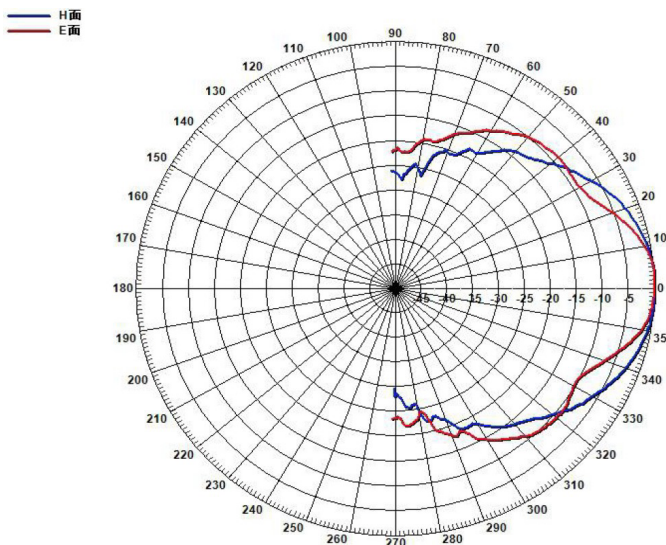

端口: 1
 频率: 22GHz
 增益: 13.1 dB
 H面波束宽度:
 -3dB: 41.02°
 E面波束宽度:
 -3dB: 26.96°



— H面
— E面

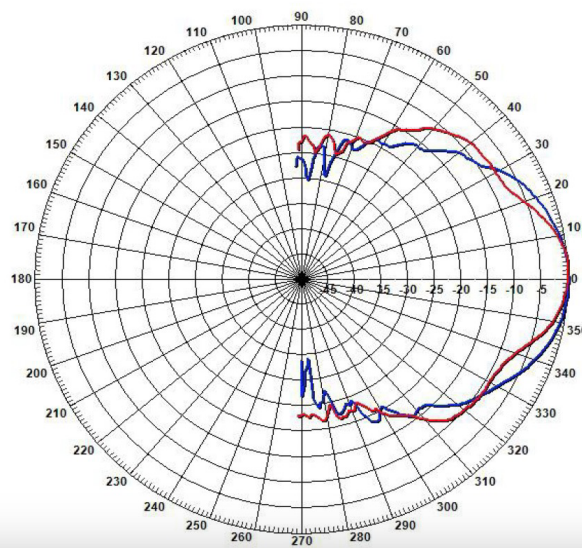

端 口: 1
 频 率: 24GHz
 增 益: 13.7 dB
 H 面波束宽度:
 -3dB: 36.91°
 E 面波束宽度:
 -3dB: 26.00°

— H面
— E面

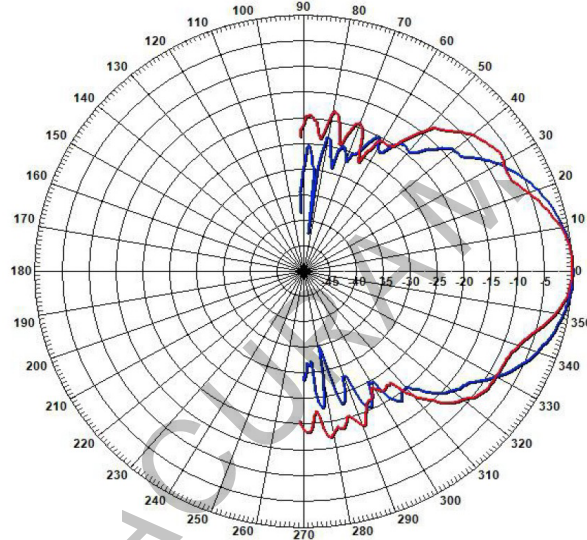

端 口: 1
 频 率: 26GHz
 增 益: 14.1 dB
 H 面波束宽度:
 -3dB: 35.14°
 E 面波束宽度:
 -3dB: 25.33°

— H面
— E面

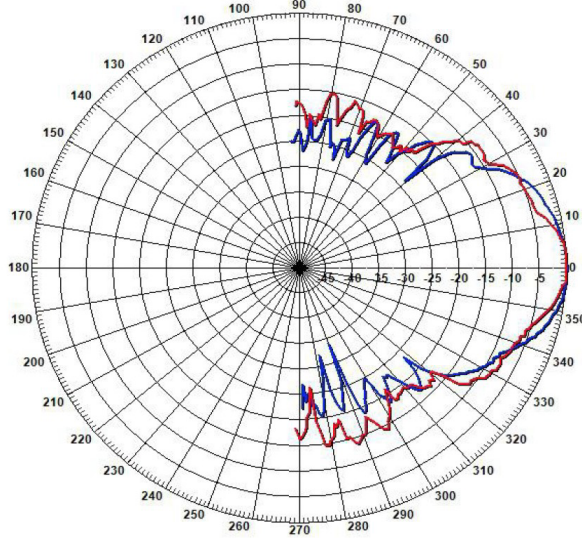

端 口: 1
 频 率: 28GHz
 增 益: 14.7 dB
 H 面波束宽度:
 -3dB: 33.03°
 E 面波束宽度:
 -3dB: 22.56°



H面
E面

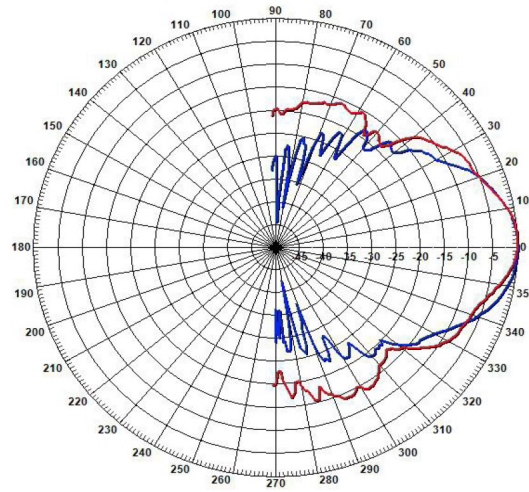

端 口: 1
频 率: 30GHz
增 益: 15.2 dB
H 面波束宽度:
-3dB: 28.71°
E 面波束宽度:
-3dB: 23.60°

H面
E面

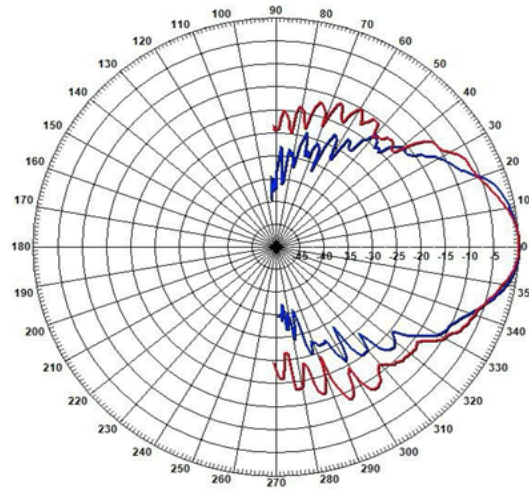

端 口: 1,
频 率: 32GHz,
增 益: 15.2 dB
H 面波束宽度:
-3dB: 28.65°
E 面波束宽度:
-3dB: 23.53°

H面
E面

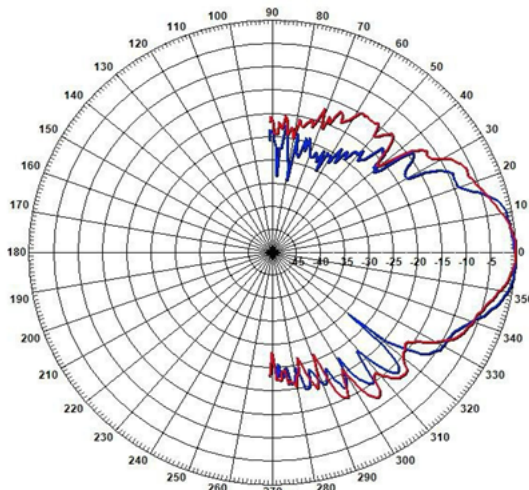

端 口: 1,
频 率: 34GHz,
增 益: 15.4 dB
H 面波束宽度:
-3dB: 28.80°
E 面波束宽度:
-3dB: 23.17°

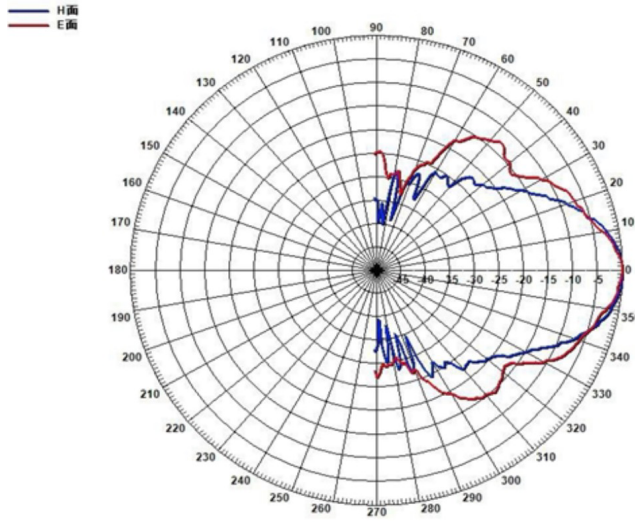

端 口 : 1.,
 频 率 : 36GHz.,
 增 益 : 16.7-dB
 H-面波束宽度.:
 -3dB: .. 23.25°
 E-面波束宽度.:
 -3dB: .. 20.32°

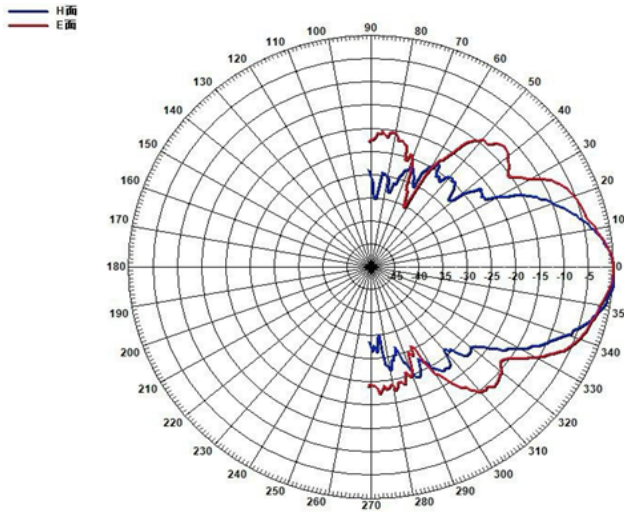

端 口 : 1.,
 频 率 : 38GHz.,
 增 益 : 16.3-dB
 H-面波束宽度.:
 -3dB: .. 22.00°
 E-面波束宽度.:
 -3dB: .. 24.00°

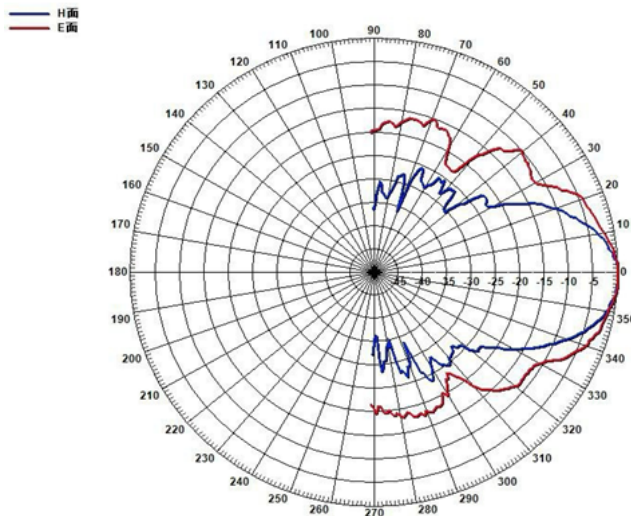

端 口 : 1.,
 频 率 : 40GHz.,
 增 益 : 16.3-dB
 H-面波束宽度.:
 -3dB: .. 22.04°
 E-面波束宽度.:
 -3dB: .. 29.60°